

10 11 12 13 14 15 16 17 18 19 20 21 22 23 24 25 26 27 28 29 30 31 32 33 34 35 36 37

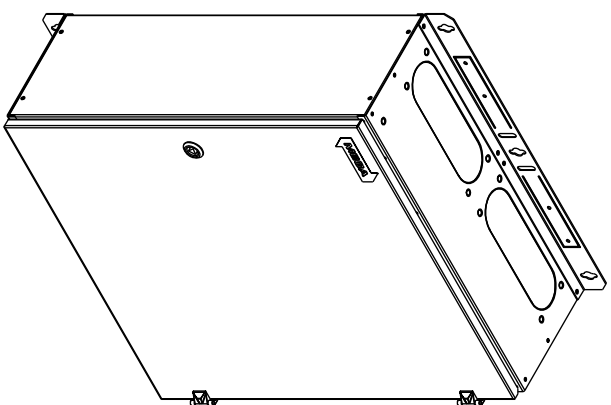
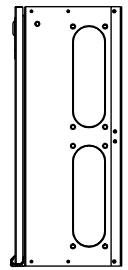
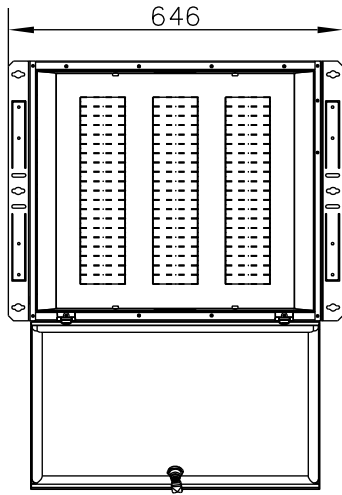
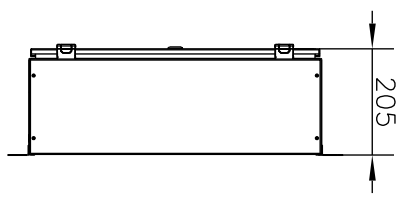
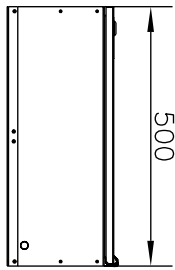

Työpaikkakeskus FE TPK-L

- TPK-L
- Pinta-asetteinen
- 60 moduulipaikkaa
- Koteloin materiaali RST (AISI 204)
- Keskuksen tausta umpinainen
- IP44
- Ovi varustettu kolmiokaralukolla
- Toimitus sisältää tarvittavat läpivientitarvikkeet

Lisävarusteet: www.pok.fi

POK Group
PRODUCTS | www.pok.fi

Un	230/400 V	fn	50 Hz	Nome	TPK-L
Ira	A	I _w	<5 kA	Code	R10094
IP	44	I _{pk}	<7,5kA	Type	
EMC	A ja B	U _{imp}	4 kV	ID	
Sign	-	PG	XXXXXX-XX		

Kohde	
Tiloojo	
Suunn.	Rtu /30.05.2012
Tark.	
Lehti	1/1

Keskustunnus
Pirustusnumero
SÄH



S R P O N M L K J I H G F E D C B A

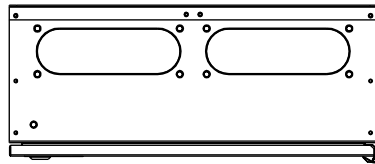
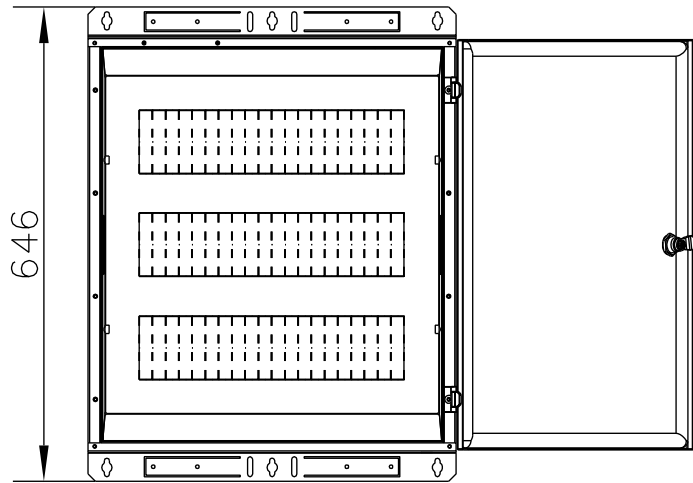
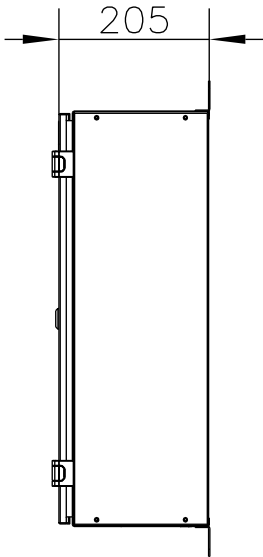
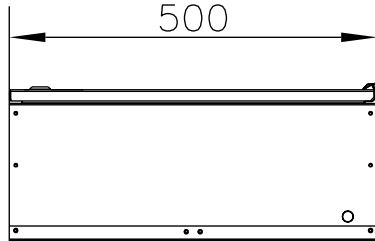

Osastointimuoto: 2-4

Jakelu järjestelmä: TN-S

Mittakaava:

POK Group
PRODUCTS | WWW.POK.FI

Un 230/400 V	fn 50 Hz	Name TPK-L	
InA A	l _{cw} <5 kA	Code R10094	Sign -
IP 44	I _{pk} <7,5kA	Type	PG XXXXX-XX
EMC A ja B	U _{imp} 4 kV	ID	