

10 11 12 13 14 15 16 17 18 19 20 21 22 23 24 25 26 27 28 29 30 31 32 33 34 35 36 37

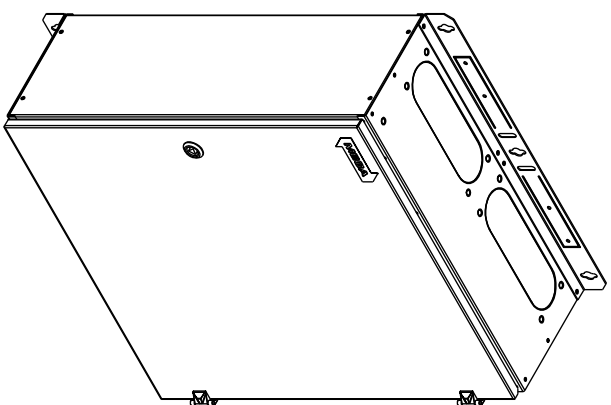
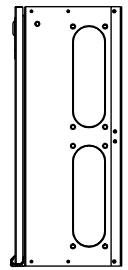
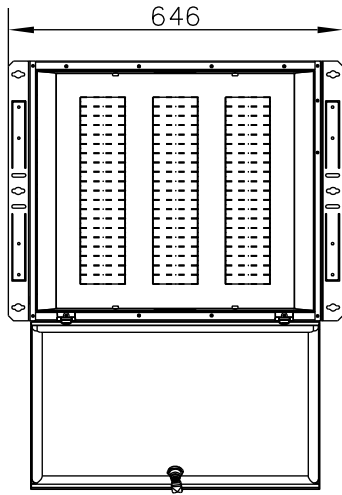
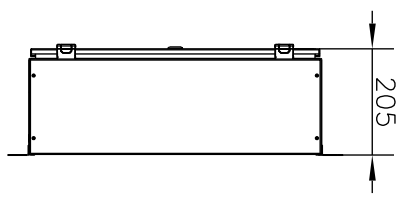
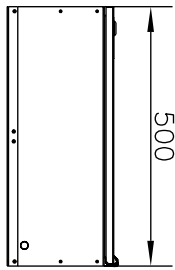

Työpaikkakeskus FE TPK-L

- TPK-L
- Pinta-asetteinen
- 60 moduulipaikkaa
- Koteloin materiaali HST (AISI 316)
- Keskuksen tausta umpinainen
- IP44
- Ovi varustettu kolmiokaralukolla
- Toimitus sisältää tarvittavat läpivientitarvikkeet

Lisävarusteet: www.pok.fi

POK Group PRODUCTS www.pok.fi		Un 230/400 V	fn 50 Hz	Nome TPK-L	Sign -
Ira A	Ikw <5 kA	Code R10097	PG XXXXX-XX	Kohde	
IP 44	Ipk <7,5kA	Type	Tiloojo		
EMC A ja B	Uimp 4 kV	ID	Suunn. RTU /30.05.2012		
			Tark. Lehti 1/1		
			Keskustunnus		
			Pirustusnumero		
			SÄH		
			Tilousnumero		

S R P O N M L K J I H G F E D C B A

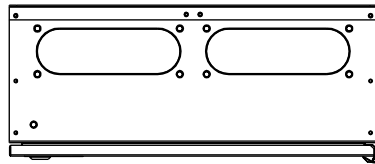
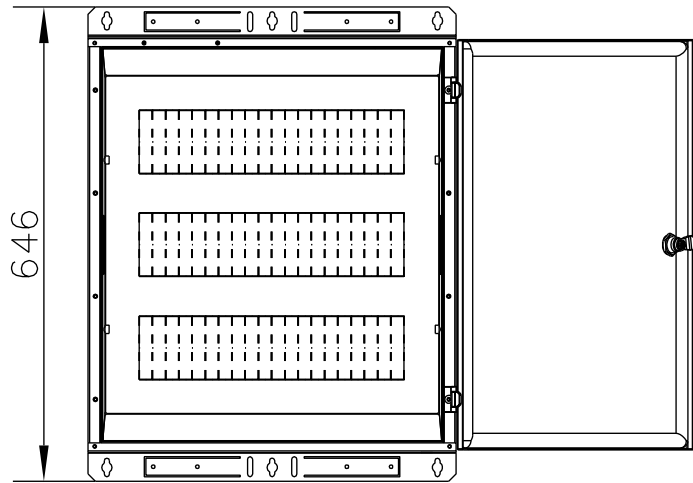
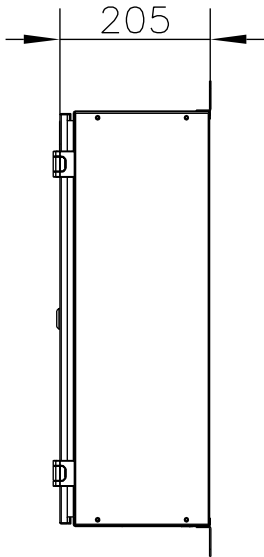
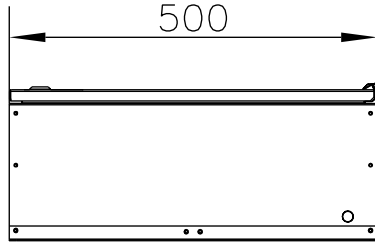

Osastointimuoto: 2-4

Jakelu järjestelmä: TN-S

Mittakaava:

POK Group
PRODUCTS | WWW.POK.FI

U _n 230/400 V	f _n 50 Hz	Name TPK-L	
I _{nA} A	I _{cw} <5 kA	Code R10097	Sign -
IP 44	I _{pk} <7,5kA	Type	PG XXXXX-XX
EMC A ja B	U _{imp} 4 kV	ID	