

Ryhmäkeskus data pinta FE RKS580P

- RKS580P
- Pinta-osenteinen
- 42 moduulipaikkaa
- Värisävy RAL9010
- keskuksen tausta avoin
- Ovi varustettu magneeteilla
- Toimitus sisältää tarvittavat läpivientilaput

Lisävarusteet: www.pok.fi

Multislim läpivientilappi:

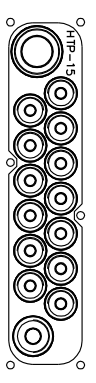

1kpl 32mm putkelle, 6–28mm kaapelille
 1kpl 25mm putkelle, 6–22mm kaapelille
 13kpl 20mm putkelle, 6–16mm kaapelille

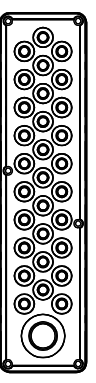

1kpl 32mm, 6–28mm kaapelille
 30kpl 20mm, 6–13mm kaapelille

Jos käytetään putketonta uppoasennusta, varmistetaan kaapelien vedonpoisto kiinnittämällä ne esim. TC-kiinnikkeillä keskuksen ulkopuolelta lähelle lappia

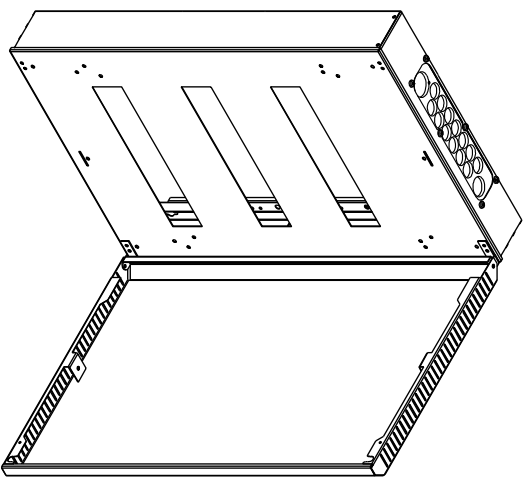

Un 230/400 V	fn 50 Hz	Name RKS580P	Sign -
Ira A	Iw <5 kA	Code R10238	PG XXXXX-XX
IP 20	Ipk <7,5kA	Type POKM	
EMC A ja B	Uimp 4 kV	ID	

Kohde	Suunn. Riit /30.05.2012	Keskustunnus	Tilausnumero
Tiloojo	Tork.	Pitruistusnumero	SÄH
	Lehti 1/1		

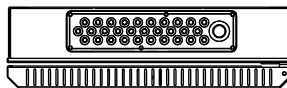
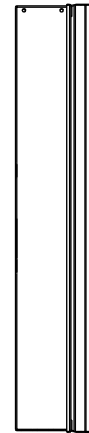
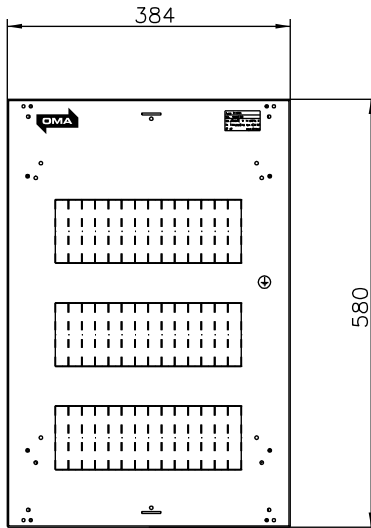
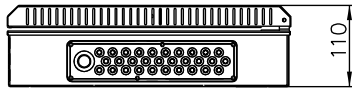

Osastointimuoto: 2-4

Jakelu järjestelmä: TN-S

Mittakaava:

POK Group
PRODUCTS | WWW.POK.FI

U _n 230/400 V	f _n 50 Hz	Name RKS580P	
I _{nA} A	I _{cw} <5 kA	Code R10238	Sign -
IP 20	I _{pk} <7,5kA	Type POKM	PG XXXXX-XX
EMC A ja B	U _{imp} 4 kV	ID	