

## Ryhmäkeskus data pinta FE RKS580P-IT

- RKS580P-IT
- Pinta-asenteinen
- Värisävy RAL9010
- Keskuksen tausta avoin
- Ovi varustettu magneeteilla
- Toimitus sisältää tarvittavat läpivientilaipat

Lisävarusteet: [www.pok.fi](http://www.pok.fi)

### Multislim läpivientilaippa:

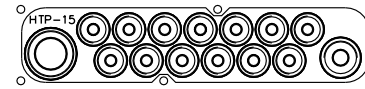

- 1kpl 32mm putkelle, 6-28mm kaapelille
- 1kpl 25mm putkelle, 6-22mm kaapelille
- 13kpl 20mm putkelle, 6-16mm kaapelille

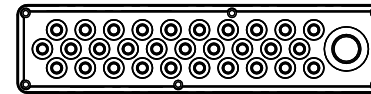

- 1kpl 32mm, 6-28mm kaapelille
- 30kpl 20mm, 6-13mm kaapelille

Jos käytetään putketonta uppoasennusta, varmistetaan kaapelien vedonpoisto kiinnittämällä ne esim. TC-kiinnikkeillä keskuksen ulkopuolelta lähelle laippaa

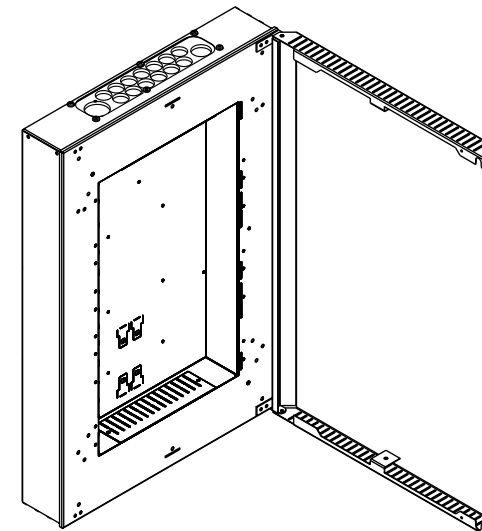

IT-tilan mitat:  
 Leveys 245mm  
 Korkeus 420mm  
 Syvyys  
 Kanteen 60mm  
 Oveen 90mm

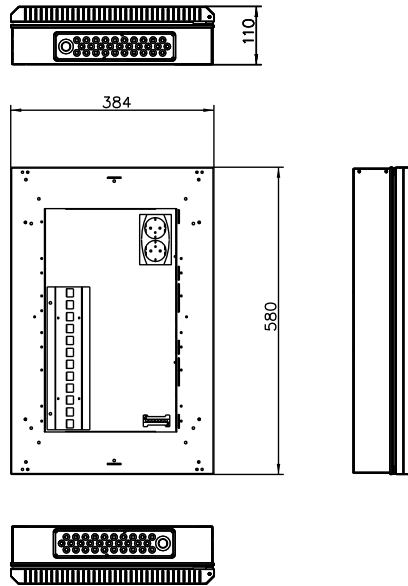

# POK

U <sub>n</sub> 230/400 V	f <sub>n</sub> 50 Hz	Name RKS580P-IT	Sign -
I <sub>nA</sub> A	I <sub>cw</sub> <5 kA	Code R10239	PG XXXXX-XX
IP 20	I <sub>pk</sub> <7,5kA	Type POKM	
EMC A ja B	U <sub>imp</sub> 4 kV	ID	

Kohde

Tilaaaja

Suunn.  
MMe /19.05.2015

Tark.

Lehti 1/1

Keskustunnus

Piirustusnumero

SÄH

Tilausnumero  
R10239\_RKS580

Osastointimuoto: 2-4

Jakelujärjestelmä: TN-S

Mittakaava:

IT-tilan mitat:  
 Leveys 245mm  
 Korkeus 420mm  
 Syvyys 60mm  
 Kanteen Oveen 90mm

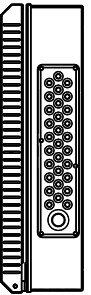
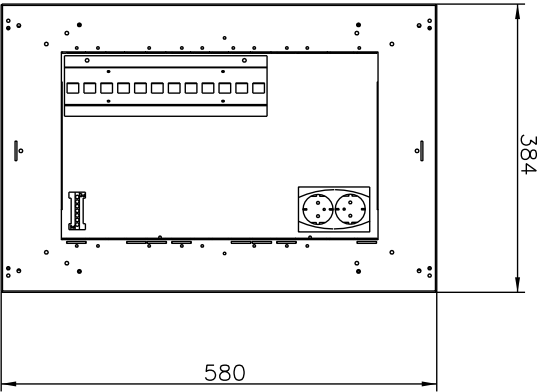
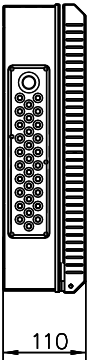

U <sub>n</sub> 230/400 V	f <sub>n</sub> 50 Hz	Name RKS580P-IT	Sign -
I <sub>nA</sub> A	I <sub>ew</sub> <5 kA	Code R10239	PG -
IP 20	I <sub>pk</sub> <7,5kA	Type POKM	XXXXXX-XX
EMC A ja B	U <sub>imp</sub> 4 kV	ID	

# POK